

SINTEF Building and Infrastructure
P.O.Box 124 Blindern
N-0314 Oslo
Tel. 47 22 96 55 55
Fax 47 22 69 54 38



Authorised and notified according to Article 10 of the Council Directive 89/106/EEC of 21 December 1988 on the approximation of laws, regulations and administrative provisions of Member States relating to construction products

MEMBER OF EOTA

European Technical Approval No. ETA-06/0251

(Replaces the version valid from 26.02.2007)

Trade name:	Protan SE, EX and EXG
Holder of approval:	Protan AS Boks 420 Brakerøya NO- 3002 Drammen Norway
Generic type and use of construction product:	System of mechanically fastened flexible roof waterproofing membranes
Valid from:	24.02.2012
to:	24.02.2017
Manufacturing plant:	Protan AS Boks 420 Brakerøya NO-3002 Drammen Norway
This European Technical Approval contains:	19 pages including 4 Annexes which form an integral part of the document



European Organisation for Technical Approvals

I LEGAL BASIS AND GENERAL CONDITIONS

- 1 This European Technical Approval is issued by SINTEF Building and Infrastructure in the following called SINTEF, in accordance with:
 - Council Directive 89/106/EEC of 21 December 1988 on the approximation of laws, regulations and administrative provisions of Member States relating to construction products¹, modified by the Council Directive 93/68/EEC² and Regulation (EC) N° 1882/2003 of the European Parliament and of the Council³
 - Common Procedural Rules for Requesting, Preparing and the Granting of European technical approvals set out in the Annex of Commission Decision 94/23/EC⁴.
 - ETA Guideline No. 006 for Systems of mechanically fastened flexible roof waterproofing membranes.
- 2 SINTEF is authorised to check whether the provisions of this European Technical Approval are met. Checking may take place in the manufacturing plant. Nevertheless, the responsibility for the conformity of the products to the European Technical Approval and for their fitness for the intended use remains with the holder of the European Technical Approval.
- 3 This European Technical Approval is not to be transferred to manufacturers or agents of manufacturers other than those indicated on page 1 of this European Technical Approval.
- 4 This European Technical Approval may be withdrawn by SINTEF in particular pursuant to information by the Commission according to Article 5(1) of Council Directive 89/106/EEC.
- 5 Reproduction of this European Technical Approval including transmission by electronic means shall be in full. However, partial reproduction can be made with the written consent of SINTEF. In this case partial reproduction has to be designated as such. Texts and drawings of advertising brochures shall not contradict or misuse the European Technical Approval.
- 6 The European Technical Approval is issued by the approval body in its official language. This version corresponds fully to the version circulated in EOTA. Translations into other languages have to be designated as such.

¹ Official Journal of the European Communities N° L40, 11.2.1989, p. 12

² Official Journal of the European Communities N° L 220, 30.08.1993, p. 1

³ Official Journal of the European Union N° L 284, 31.10.2003, p. 1

⁴ Official Journal of the European Communities N° L17, 20.1.1994, p. 34

II SPECIFIC CONDITIONS OF THE EUROPEAN TECHNICAL APPROVAL

1 Definition of the product and intended use

1.1 Definition of the product

1.1.1 General

Protan SE, EX and EXG roofing membrane kits are mechanically fastened roof waterproofing membranes, composed of single-ply Protan PVC roofing membranes and ISO-TAK Fasteners.

1.1.2 Roofing membranes

The kits may include Protan SE, Protan EX or Protan EXG which are all flexible membranes made of pliable PVC with a core of polyester fabric. Stabilisers have been added to make the material resistant to high and low temperature, ultra violet radiation, and to limit spread of flames. Joints are designed for hot air welding.

- Protan SE is used as roofing on all types of underlays. The membrane needs a separate migration barrier on polystyrene underlays and for re-roofing applications
Protan SE is produced with thickness 1.2mm, 1.6mm and 1.8mm.
- Protan EX has a laminated 180 g/m² polyesterfelt on the bottom face, and may be applied directly on old roofing underlays. The membrane may also be used in turf roof constructions and for installation on wood-based roof sheathing.
Protan EX is produced with thickness 1.2mm and 1.6mm.
- Protan EXG has a laminated 55 g/m² glass felt on the bottom face and may be applied directly on polystyrene.
Protan EXG is produced with thickness 1.2mm, 1.6mm and 1.8mm.

The membranes are manufactured with several surface colours. The underside is dark grey.

Standard measures and membrane properties are shown in [Annex 1](#).

1.1.3 Mechanical fasteners

ISO-TAK Fasteners are a range of fasteners for anchoring flexible roofing membranes, and consist of washers with integrated sleeve, washers, screws and plugs as illustrated in [Annex 2](#).

1.2 Intended use

1.2.1 General

Protan SE, EX and EXG may be used on flat and sloped roofs. The supporting roof deck may be of profiled steel sheets, concrete, light weight concrete or a wood based construction.

The type of membrane may be chosen according to the description in cl. 1.1.2. The roofing membranes may be installed directly on insulation materials as underlay. Assessments regarding thermal insulation for the complete roof is not part of this ETA, and has to be verified separately.

1.2.2 Assumed working life

The provisions made in this European Technical Approval are based on an assumed intended working life of 10 years. The indications given on the working life cannot be interpreted as a guarantee given by the producer, but are to be regarded only as a means for choosing the right products in relation to the expected economically reasonable working life of the works.

2 Characteristics of the system and methods of verification

2.1 Mechanical resistance and stability (ER1)

Not relevant.

2.2 Safety in case of fire (ER2)

Protan SE, EX and EXG roofing membranes have been tested according to ENV 1187- Part 1 and Part 2 on different substrates, and classified according to EN 13501-5 as follows:

Class B_{ROOF} (t1) is valid for the following conditions, and for the following end use conditions:

- a) roof pitches up to 20°
- b) decks of profiled and non-profiled steel sheets, and any non-combustible continuous deck with a minimum thickness of 10 mm
- c) insulation materials of PUR, EPS and mineral wool with minimum thickness 120 mm

Class B_{ROOF} (t2) is valid for the following conditions, and for the following end use conditions:

- a) Valid for all pitches
- b) Protan SE on a substrate of 50 mm mineral wool with density 150 kg/m³ and 19 mm particle board
- c) Protan SE on a substrate of a 50 g/m² migration barrier and 50 mm EPS/XPS
- d) Protan EX 1.2mm on a substrate of bitumen-based roofing and a substrate of 50mm EPS with density 20 kg/m³ and 19mm particle board
- e) Protan EXG 1.2mm on a substrate of 50mm EPS with density 20 kg/m³ and 19mm ordinary particle board
- f) Test results obtained for a roof covering attached to a substrate apply only for the roof covering on substrates having a density greater than or equal to 0.75 times the density used in the test
- g) Test results obtained on a non-combustible standard substrate apply only for non-combustible substrates which also comply with e)
- h) Test results obtained on a combustible standard substrate apply to combustible and non-combustible substrates which also comply with f)

2.3 Hygiene, health and the environment (ER3)

According to the manufacturers' declarations the screws and washers of the fasteners having a protection film contain a minor remaining quantity of chromium compounds. Otherwise the products do not contain any dangerous substances according to the EU's database.⁵

⁵ In addition to the specific clauses relating to dangerous substances contained in this European Technical Approval, there may be other requirements applicable to the product falling within its scope (e.g. transposed European legislation and national laws, regulations and administrative provisions). In order to meet the provisions of the EU Construction Products Directive, these requirements need also to be complied with, when and where they apply.

2.4 Safety in use (ER4)

Table 1 shows the maximum design wind uplift resistance per fastener, determined according to ETAG 006 ch. 5.1.4.1 for various combinations of Protan SE 1.2 roofing membrane and fasteners.

Table 1
Design wind uplift resistance for Protan SE 1.2 with various fasteners

Fastener	Screw	Substrate	Max. design load [N]
ISO-TAK Fastening plug	ISO-TAK Steel Deck Screw BS/PS 48 - Ø 4,8 mm,	0.75 mm steel deck	580
ISO-TAK Twin Peak Plus fastening plug	ISO-TAK Steel Deck Screw BS/PS 48 - Ø 4,8 mm,	0.75 mm steel deck	910
ISO-TAK Washer 82x40mm	ISO-TAK Steel Deck Screw DB 48 - Ø 4,8 mm,	0.75 mm steel deck	730
ISO-TAK Washer 82x40mm with studs	ISO-TAK Steel Deck Screw DB 48 - Ø 4,8 mm,	0.75 mm steel deck	970
ISO-TAK 40 Metal-Stress Plate	ISO-TAK wood screw TS-5,2	Wood	660
ISO-TAK Plus 48-3N Fastening Plug with three studs	ISO-TAK Steel Deck Screw PS 48 - Ø 4,8 mm	0.7 mm steel deck	830

Axial pull out loads for ISO-TAK fasteners in various substrates are shown in [Annex 3](#). For fastening to substrates where the fastener has less design pullout resistance than the values in Table 1, determined according to the provisions in ETAG 006, the smaller value must be used.

The design loads shown in Table 1 for fasteners with rectangular plugs or washers may also be applied for similar round fasteners, as long as the diameter is equal to or larger than the minimum width of the rectangular plug or washer.

2.5 Aspects of durability

The kit components has been tested for durability with results as shown in Annex 1 Table 1.5 for the Protan SE, EX and EXG roofing membranes, and as shown in Annex 3. for the ISO-TAK fasteners.

2.6 Identification

In addition to the product descriptions given in Annex 1 and Annex 2 the characteristic values of detailed product dimensions and respective tolerances are stated in the manufacturer's technical dossier and form a part of the control plan for the factory production control.

3 Evaluation of Conformity and CE marking

3.1 Attestation of Conformity System

The European Commission according to the decision (98/143/EC of February 1998, Official Journal of the European Communities No. L 42, 14/02/1998) on the Procedure of Attestation of Conformity has, for this type of product, laid down system 2+ for the procedure of attestation of conformity (Annex III, clause 2(ii) first possibility of Directive 89/106/EC) for Systems of mechanically fastened flexible roof waterproofing membranes. This system of attestation of conformity is defined as follows:

- (a) Tasks of the manufacturer:
 - Factory production control;
 - Initial type testing of the product;
 - testing of samples taken at the factory in accordance with a prescribed test plan
- (b) Tasks of the notified body: certification of factory production control on the basis of:
 - Initial inspection of the factory and factory production control (FPC);
 - Continuous surveillance, assessment and approval of factory production control.

According to the Decision 98/599/EC of the European Commission (Official Journal of the European Communities L 29/38 of 25 January 1999) system 3 of attestation of conformity (Annex III, clause 2(ii) second possibility of Directive 89/106/EEC) applies with regard to external fire performance of roofs (class BROOF (ti)).

System 3: Declaration of conformity of the product by the manufacturer on the basis of:

- (a) Task for the manufacturer: - Factory production control;
- (b) Task for the notified body: - Initial type-testing of the product.

3.2 Responsibilities

3.2.1 Tasks of the manufacturers

Factory production control

The manufacturers of membranes and the fasteners shall exercise permanent internal control of the production. All the elements, requirements and provisions adopted by the manufacturers shall be documented in a systematic manner in the form of written policies, procedures and a control plan, including records of results performed. This production control system shall ensure that the product is in conformity with this European technical approval. The factory production control includes checking of incoming materials and process controls.

The manufacturer shall use raw materials or components that comply with the specifications in the control plan. The results of the factory production control shall be recorded and evaluated. The records shall include at least the following information:

- Name of the product and the raw materials
- Type of inspection or control
- Date of manufacture, batch number, and date of inspection or control of the product
- Results of inspections or controls and, as far as applicable, comparison with requirements
- Signature of the person responsible for factory production control

The records shall be kept for at least five years. Further information concerning tests, their frequency and tolerances, is included in the test plan which is deposited at SINTEF.

Initial type-testing of the product

Approval tests have been conducted by SINTEF and other approved bodies in Europe in accordance with ETA Guideline N° 006. SINTEF has assessed the results of these tests in accordance with ETAG 006 ch. 6, and the product characteristics determined by the initial test programme have been found acceptable to serve as initial type-testing. Otherwise the necessary initial type-testing shall be carried out according to the provisions of the control plan and observance of the required property values shall be ascertained by the notified body. After changing the production process or starting the production in another manufacturing plant the initial type-testing shall be repeated.

Other tasks for the manufacturer

The manufacturer shall, on the basis of a contract, involve a body/bodies which is/are notified for the tasks referred to in section 3.1 in the field of the product in order to undertake the actions laid down in section 3.2.2. For this purpose, the control plan referred to in section 3.2.2 shall be handed over by the manufacturer to the notified body/bodies involved.

The manufacturer shall make a declaration of conformity, stating that the product is in conformity with the provisions of this ETA.

3.2.2 Tasks of notified bodies*Initial inspection of factory and factory production control*

SINTEF has performed initial factory inspection as approval body, and ascertains that the manufacturer has acceptable premises, technical equipment, qualified personnel and a factory production control system with a control plan in accordance with the provisions in ETA Guideline 006 and in this ETA. This inspection may serve as initial factory inspection.

Continuous surveillance, assessment and approval of factory production control

The notified body shall perform continuous surveillance and assessment of the manufacturer's factory production control, and confirm that the controls are made in conformity with the established control plans approved by SINTEF.

The notified body shall issue an EC certificate of conformity of the factory production control stating the conformity with the provisions of this European technical approval. In cases where the provisions of the European technical approval and its Control Plan are no longer fulfilled the certification body shall withdraw the certificate of conformity and inform SINTEF without delay.

Initial type-testing with regard to external fire performance

The appropriate part of the control plan states the information on the reaction to fire properties which have to be tested on initial type-testing by the notified body. In case of need it will be handed over for initial type-testing of the product to the notified body recognized for initial type-testing. If the verifications underlying the ETA have been furnished on samples from the current production, these will replace the initial type-testing. Otherwise the necessary initial type-testing shall be carried out according to the provisions of the control plan and observance of the required property values required in the ETA shall be ascertained by the notified body.

After changing the production process or starting the production in another manufacturing plant the initial type-testing shall be repeated.

3.3 CE marking

The CE mark shall be affixed to the kits/components, an attached label, the packaging, or the accompanying commercial documents. The symbol "CE" shall be followed by the following additional information:

- name and address or identifying mark of the manufacturer
- last two digits of the year in which the CE marking was affixed
- number of the EC certificate for the factory production control
- number of the European Technical Approval
- ETAG 006

The components shall be marked as belonging to the kit.

4 Assumptions under which the fitness of the product for the intended use was favourably assessed

4.1 Manufacturing

The European technical approval is issued for the product on the basis of agreed data/information, deposited with SINTEF, which identifies the product that has been assessed and judged. Changes to the product or production process, which could result in this deposited data/information being incorrect, should be notified to SINTEF before the changes are introduced. SINTEF will decide whether or not such changes affect the ETA and consequently the validity of the CE marking on the basis of the ETA, and if so whether further assessment or alterations to the ETA shall be necessary.

4.2 Installation and design

The joints of Protan SE, EX and EXG roofing membranes are hot air welded, and shall be installed in accordance with the principles shown in Annex 4 and the manufacturer's installation guide. Minimum overlap shall be 120 mm for sidelaps and 100 mm for end lap joints.

Calculation of fastener spacings must be carried out according to the relevant national rules for wind actions and safety factors for design loads.

4.3 Substrates

General

Fastening with steel washers may be used in longitudinal overlap joints on stiff underlays, i.e. on wood-based roof sheathing or on concrete.

Plastic fasteners with integrated sleeve are recommended on underlays of thermal insulation materials. The insulation material should have a compressive stress ≥ 60 kPa at 10% deformation according to EN 826.

Fastening in concrete

When fixing ISO-TAK concrete nails and screws the drill hole diameter must be 5 mm. The drill hole depth should be 30 mm, unless special precautions are taken regarding installation control and inspection. Minimum anchorage depth shall be 20 mm. Fixings in 50 mm thick concrete without penetration requires precise length/depth control.

Fastening in light weight concrete

When fixing ISO-TAK Light Weight Concrete Expansion Plug 45 and 75 in aerated concrete the drill hole diameter must be 15 mm, and the minimum depth 65 mm.

When fixing ISO-TAK Light Weight Concrete Screw LBS 8 mm the anchorage depth must be minimum 75 mm.

Fastening in metal decks

Loadbearing decks made of profiled steel sheets shall have a minimum thickness of 0.7 mm. In particularly exposed areas the recommended minimum thickness is 0.8 mm for fixing roofing membranes to the steel decks.

4.4 Roof traffic

When the expected roof traffic may exceed what is required for normal inspection visits and maintenance, special measures should be taken to protect the roofing membrane.

5 Indications to the manufacturer

5.1 Packaging, transport and storage

Protan SE, EX and EXG roofing membranes should be stored in a dry place, with the rolls placed on pallets and protected by a covering at the building site. The Protan SE, EX and EXG membranes must be kept away from any source of heat, sparks, flame, etc. The fasteners shall be handled and stored with care and be protected from accidental damage.

5.2 Use, maintenance, repair

It is the responsibility of the manufacturer to ensure that proper information for the use of the Protan SE, EX and EXG membranes and ISO-TAK Fasteners is available at each delivery, including general guidance on the basis of this ETA. The assessment of the fitness for use is based on the assumption that a normal maintenance of the system is performed. Further details about maintenance is stated in the manufacturers' installation guide.

The Protan SE, EX and EXG roofing membranes must be cleaned locally before starting any welding of joints as a part of repair work.

On behalf of
SINTEF Building and Infrastructure
Oslo, 24.02.2012



Tore H. Erichsen
Approval Manager

Annex 1

Specifications and properties of Protan roofing membranes

Table 1.1 Measures for Protan SE range of membranes

	Protan SE			Protan EXG		Protan EX		
Thickness (mm)	1.2	1.6	1.8	1.2	1.6	1.2	1.6	1.8
Weight (kg/m ²)	1.4	1.75	2.1	1.4	1.75	1.4	1.75	2.1
Width	1 m & 2 m	1 m & 2 m	1 m & 2 m	1 m & 2 m	1 m & 2 m	1 m & 2 m	1 m & 2 m	1 m & 2 m
Roll length	20 m	20 m	20 m	20 m	20 m	20 m	20 m	20 m
Weight of glass felt				55 g/m ²				
Weight of polyester felt							180 g/m ²	

Table 1.2 Product properties for Protan SE 1.2, Protan SE 1.6 and Protan SE 1.8

ER	Clause in ETAG 006	Property	Test method	Mean value	
3	5.2.3.1	Peel resistance of joints	EN 12316-2	150 N	
	5.2.3.2	Shear resistance of joints	EN 12317-2	1000 N	
	5.2.3.3	Resistance to tear L/T	EN 12310-2	210/210 N	
	5.2.3.4	Resistance to cold folding	EN 495-5	-30 °C	
	5.2.3.5	Resistance to water pressure	EN 1928	Tight	
	5.2.3.6	Moisture resistance factor ¹⁾	Water vapour resistance as equivalent air layer thickness (S _d -value) ¹⁾ a: SE 1.2 b: SE 1.6 c: SE 1.8	EN 1931	μ=13 500
				EN ISO 12572	a: 16 m b: 22 m c: 24,5 m
				EN 12311-2	1050/1050 N 15/15 %
5.2.3.7	Tensile properties L/T -Tensile strength -Elongation	EN 12311-2	1050/1050 N 15/15 %		
5.2.3.8	Resistance to static loading	EN 12730	20 kg		
5.2.3.8	Resistance to impact load at +23 °C a: SE 1.2 b: SE 1.6 c: SE 1.8	EN 12691:2006	a: 450 mm b: 600 mm c: 700 mm		
4	5.2.4.1	Slipperiness	DIN 53375 (1986)	0,74/0,71 μS/μD	

¹⁾ Limiting value; one product measured, the others calculated

Table 1.3 Product properties for Protan EX 1.2, Protan EX 1.6 and Protan EX 1.8

ER	Clause in ETAG 006	Property	Test method	Mean value	
3	5.2.3.1	Peel resistance of joints	EN 12316-2	150 N	
	5.2.3.2	Shear resistance of joints	EN 12317-2	1000 N	
	5.2.3.3	Resistance to tear L/T	EN 12310-2	300/300 N	
	5.2.3.4	Resistance to cold folding	EN 495-5	-30 °C	
	5.2.3.5	Resistance to water pressure	EN 1928	Tight	
	5.2.3.6	Moisture resistance factor ¹⁾	Water vapour resistance as equivalent air layer thickness (S _d -value) ¹⁾ a: EX 1.2 b: EX 1.6 c: EX 1.8	EN 1931	μ=13 500
				EN ISO 12572	a: 16 m b: 22 m c: 24,5 m
				EN 12311-2	1100/1100 N 15/15 %
5.2.3.7	Tensile properties L/T -Tensile strength -Elongation	EN 12311-2	1100/1100 N 15/15 %		
5.2.3.8	Resistance to static loading	EN 12730	20 kg		
5.2.3.8	Resistance to impact load at +23 °C a: EX 1.2 b: EX 1.6 c: EX 1.8	EN 12691:2006	a: 500 mm b: 600 mm c: 700 mm		
4	5.2.4.1	Slipperiness	DIN 53375 (1986)	0,74/0,71 μS/μD	

¹⁾ Calculated values according to similar products

Table 1.4 Product properties for Protan EXG 1.2 and Protan EXG 1.6

ER	Clause in ETAG 006	Property	Test method	Mean value
3	5.2.3.1	Peel resistance of joint	EN 12316-2	150 N
	5.2.3.2	Shear resistance of joints	EN 12317-2	1000 N
	5.2.3.3	Resistance to tear L/T	EN 12310-2	210/210 N
	5.2.3.4	Resistance to cold folding	EN 495-5	-30 °C
	5.2.3.5	Resistance to water pressure	EN 1928	Tight
	5.2.3.6	Moisture resistance factor ¹⁾	EN 1931	$\mu=13\ 500$
		Water vapour resistance as equivalent air layer thickness (S_d -value) ¹⁾ a: EXG 1.2 b: EXG 1.6	EN ISO 12572	a: 16 m b: 22 m
	5.2.3.7	Tensile properties L/T -Tensile strength -Elongation	EN 12311-2	1050/1050 N 15/15 %
	5.2.3.8	Resistance to static loading	EN 12730	20 kg
5.2.3.8	Resistance to impact load at +23 °C a: EXG 1.2 b: EXG 1.6	EN 12691:2006	a: 450 mm b: 600 mm	
4	5.2.4.1	Slipperiness	DIN 53375 (1986)	0,74/0,71 $\mu\text{S}/\mu\text{D}$

¹⁾ Calculated values according to similar products

Table 1.5 Assessment of durability for Protan SE, EX and EXG

Clause in ETAG 006	Property	Method of artificial ageing	Test method	Mean value	Remarks
5.2.7.1	Testing of peel resistance	EN 1296	EN 12316-2	$\Delta \leq 11 \%$	
5.2.7.1	Testing of peel resistance	EN 1296	EN 12316-2	$\Delta \geq 0 \%$	
5.2.7.2	Testing of shear	EN1296	EN 12317-2	$\Delta \geq 0 \%$	
5.2.7.3	Testing of tear	EN 1296	EN 12310-2	$\Delta = -6/0$	L/T
5.2.7.4	Resistance of cold folding	EN 1297	EN 495-5	$\Delta \leq 10 \text{ °C}$	Method prEN 1297 with 5000 h exposure
5.2.7.5	Determination of dimensional stability		EN 1107	-0.5/+0.5 %	

Annex 2

Description of ISO-TAK Fasteners

Fastener type	Fig. no., see following pages	Function	Material
ISO-TAK 45 and 75	1	Fastening plug	Polypropylene
ISO-TAK 45 and 75 LB	2	Fastening plug	Polypropylene
ISO-TAK RP 45 Plus ISO-TAK RP 75 Plus	24	Fastening plug	Polypropylene
ISO-TAK Twin Peak	3	Fastening plug	Polypropylene
ISO-TAK Plus 48-3N	5	Fastening plug	Polypropylene
ISO-TAK Twin Peak Plus	4	Fastening plug	Polyamid
ISO-TAK PP-45 – Mast	20	Barbed plate	Polyamid
ISO-TAK 40 Metal – Stress plate	6	Washer	Steel
ISO-TAK Washer SP-A-8240 D1& D2	7	Washer	Steel
ISO-TAK Washer SP-A-8240 D4	8	Washer with studs	Steel
ISO-TAK Concrete Nail Ø 5.5mm	9	Nail	Stainless steel
ISO-TAK Concrete Nail Ø 5.0/5.7mm	10	Nail	Stainless steel
ISO-TAK Concrete Screw Plug 7.5 x 100mm	11	Screw plug	Stainless steel
ISO-TAK CS-6.1	12	Concrete screw	Stainless steel
ISO-TAK LBS-8	13	Light weight concrete screw	Steel with corrosion protection
ISO-TAK BSP 8-50	14	Fastening plug	Polyamid
ISO-TAK PS 48 – Ø 4.8mm	15	Steel deck screw	Steel with corrosion protection
ISO-TAK BS 48 – Ø 4.8mm	16	Steel deck screw	Steel with corrosion protection
ISO-TAK DS 48 – Ø 4.8mm	17	Steel deck screw	Steel with corrosion protection
ISO-TAK BS 55 – Ø 5.5mm	18	Steel deck screw	Steel with corrosion protection
ISO-TAK BS 61 – Ø 6.1mm	19	Steel deck screw	Steel with corrosion protection
ISO-TAK TS – 5.2	21	Timber deck screw	Steel with corrosion protection
ISO-TAK CP 50-8	22	Concrete plug	Polyamid
ISO-TAK LBS-6	23	Light weight concrete screw	Steel with corrosion protection
ISO – TAK HD - 6.1	25	Screw for steel, concrete and woodbased decks	Steel with corrosion protection

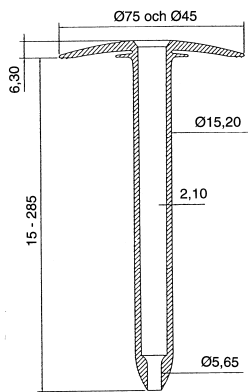

Fig. 1
ISO-TAK 45 and 75
Fastening Plug

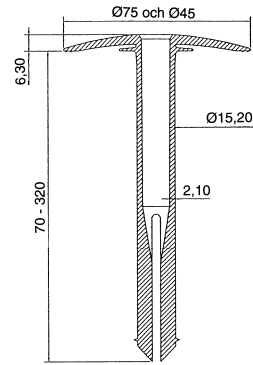

Fig. 2
ISO-TAK LB 45 and 75
Light Weight Concrete
Expansion Plug

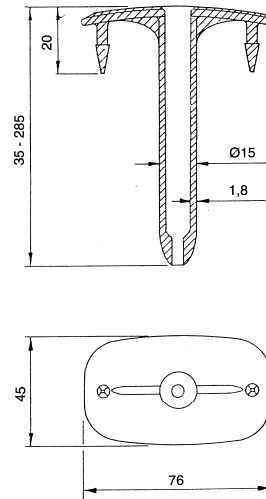

Fig. 3
ISO-TAK Twin Peak
Fastening Plug

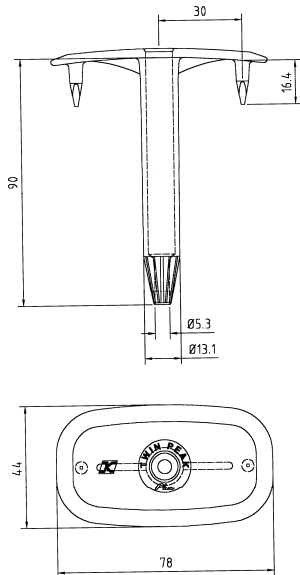

Fig. 4
ISO-TAK Twin Peak Plus
Fastening Plug

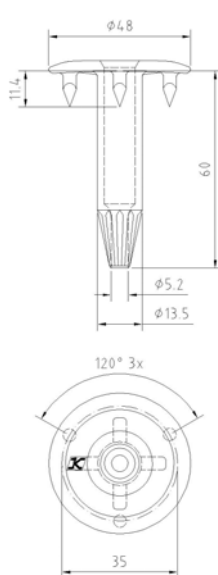

Fig 5
ISO-TAK Plus 48-3N
Fastening Plug with
three studs

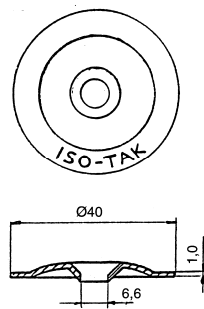

Fig. 6
ISO-TAK 40
Metal -Stress
Plate

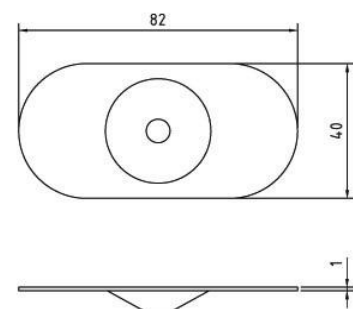

Fig. 7
ISO-TAK Washer 82 x 40 mm
SP-A-8240 D1 & D2

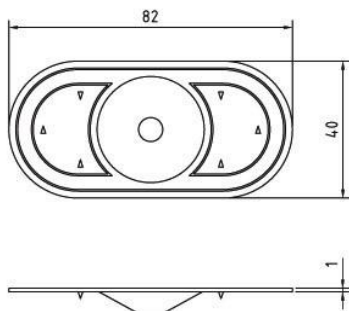

Fig. 8
ISO-TAK Washer 82x40 mm
SPB-8240 D4, with studs

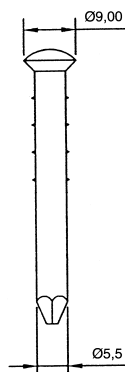

Fig. 9
ISO-TAK Concrete
Nail Ø 5,5 mm

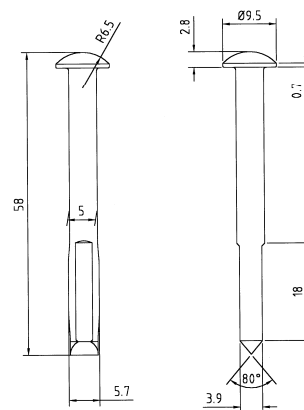

Fig. 10
ISO-TAK Concrete Nail
Ø 5,0 / 5,7 mm

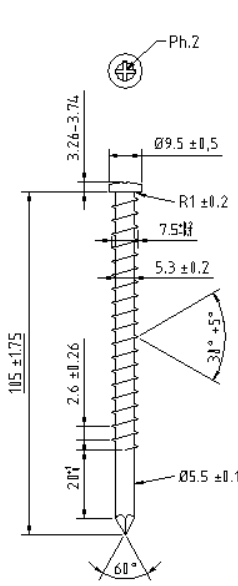

Fig. 11
ISO-TAK Concrete Nail-Screw
Screw Plug 7,5 x 105
mm adjustable fastener

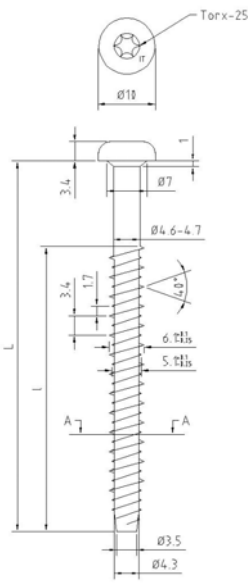

Fig. 12
ISO-TAK Concrete Screw
CS-6.1

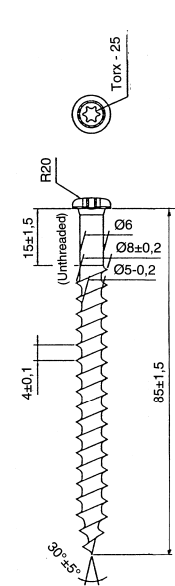

Fig. 13
ISO-TAK Light Weight
Concrete Screw
LBS-8, steel SAE 1018,
with Endurogard 15®
corrosion protection

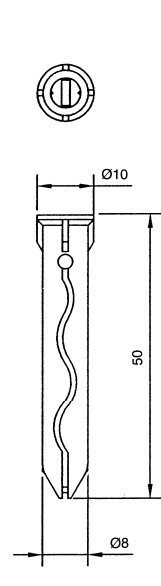

Fig. 14
ISO-TAK
BSP 8-50,
Polyamid

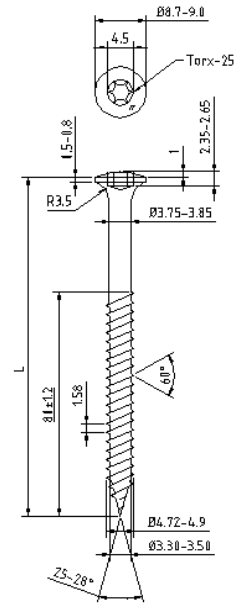

Fig. 15
ISO-TAK Steel Deck Screw
PS 48 - Ø 4,8 mm,
tempered steel SHE 1018,
normal point, trumpet head,
and Torx-25 countersunk
hexagon head

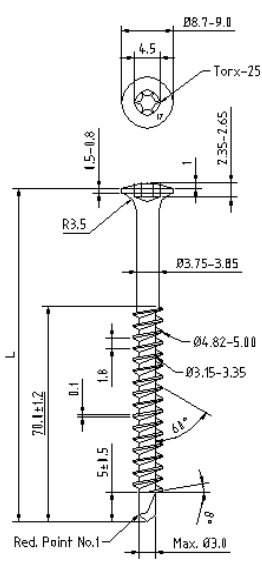

Fig. 16
ISO-TAK Steel Deck Screw
BS 48 - Ø 4,8 mm,
tempered steel SHE 1022,
drill point, trumpet head, and
Torx-25 countersunk hexagon
head

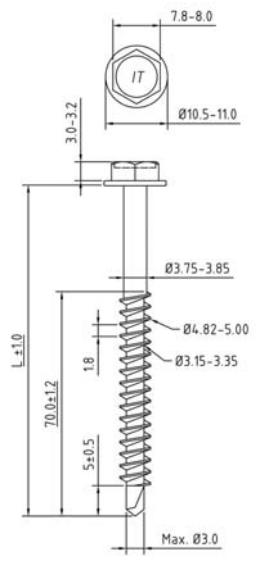

Fig. 17
ISO-TAK Steel Deck Screw
DB 48 - Ø 4,8 mm,
tempered steel SHE 1022,
drill point, hexagon head

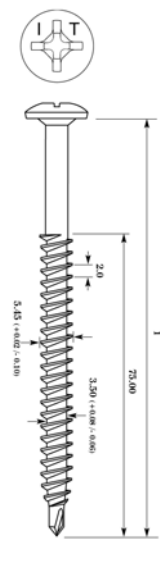

Fig. 18
ISO-TAK Steel Deck Screw
BS 55 - Ø 5,5 mm,
tempered steel SHE 1022,
drill point, trumpet head, Ph 3
cross-head

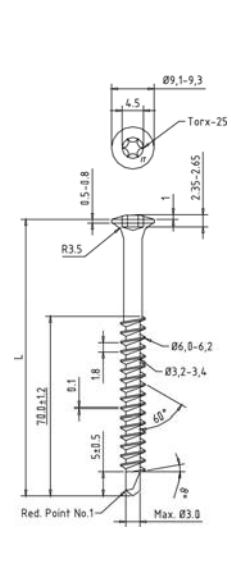

Fig. 19
ISO-TAK screw
BS61 - Ø 6,1 mm,
tempered steel SHE 1022
with drill point and trumpet
head

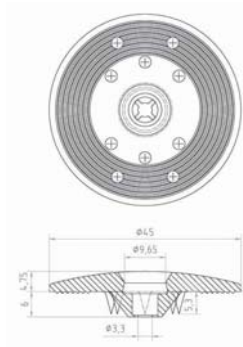

Fig. 20
ISO-TAK PP-45 – Mast
45 mm barbed plate
made of polyamid

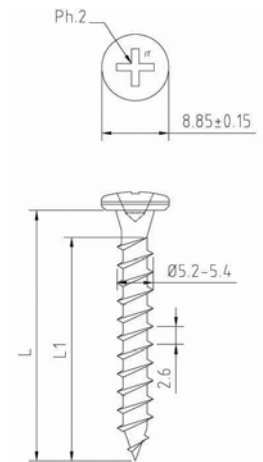

Fig. 21
ISO-TAK TS – 5.2
fasteners for fastening to
timber decking

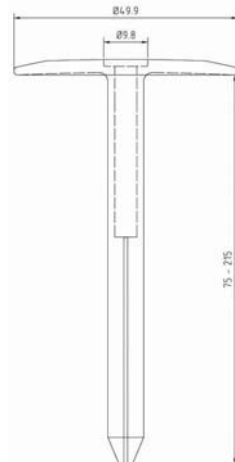

Fig. 22
ISO-TAK Concrete
Fastener CP 50-8

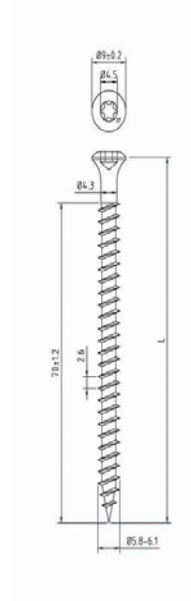

Fig. 23
ISO-TAK Light-
weight concrete
screw LBS-6
steel SAE 1018,
with Endurogard
15® corrosion
protection

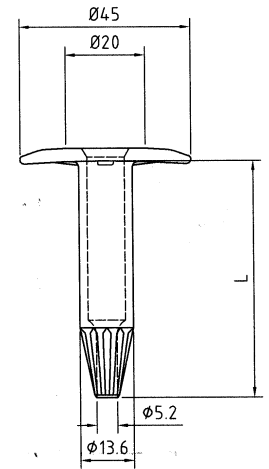

Fig.24
ISO-TAK RP 45 and 75 Plus
Fastening Plug

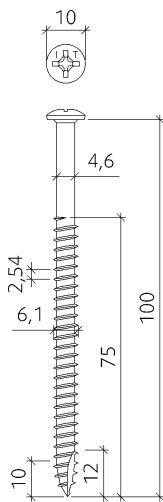

Fig. 25
ISO-TAK HD – 6.1
Screw for fastening in
concrete, steel- and
timber decks

Annex 3

Performance of ISO-TAK Fasteners

Fastener	Substrate	Axial pull out load ETAG 006 § 5.3.4.1	Durability ETAG 006 §§ 5.3.7.1 and 5.3.7.2
Profiled metal decking substrate ¹⁾			
ISO-TAK PS-4.8	Steel 0.7mm	1330 N	Pass
ISO-TAK BS-4.8	Steel 0.7mm	1200 N	
ISO-TAK DB(T)-4.8	Steel 0.8mm	1280 N	
ISO-TAK BS-5.5	Steel 0.7mm	1350 N	
ISO-TAK BS-6.1	Steel 0.7mm	1920 N	
ISO-TAK BS-6.1 ¹⁾	Steel 1.25mm	4140 N	
ISO-TAK HD-6.1	Steel 0.8mm	1590 N	
Concrete substrate ⁵⁾			
ISO-TAK HD-6.1	C25 - C30	8260 N	Pass
ISO-TAK BNRF-5.0/5.7	C55 - C67	2490 N	Stainless A-2
ISO-TAK ASRF-7.5	C55 - C67	1890 N	
ISO-TAK CS-6.1	C55 - C67	2160 N	Pass
ISO-TAK CP-50/8 (polyamid)	C25 - C30	1750 N	
ISO-TAK BSP+PS-4.8 (polyamid)	C55 - C67	4930 N	
Light weight concrete substrate ⁵⁾			
ISO-TAK LBS-6.0	Ytong ^{TM 2)} Density 600 kg/m ³	2360 N	Pass
ISO-TAK LBS-8.0	Scanpor ^{TM 2)} Density 500 kg/m ³	2100 N	
ISO-TAK BSP+PS-4.8	Leca Tag- element ^{TM 3)}	2900 N	
ISO-TAK LB (polypropylene)	Siporex ^{TM 2)} Density 500 kg/m ³	1570 N	
ISO-TAK LB (polypropylene)	Siporex ^{TM 2)} Density 450 kg/m ³	1370 N	
Wood substrate			
ISO-TAK HD-6.1	18 mm OSB/3 ⁴⁾	1590 N	Pass
ISO-TAK TS-5.2	18 mm OSB/3 ⁴⁾⁾	2000 N	

¹⁾ Steel sheets, galvanised, min S280 according to EN 10147

²⁾ Autoclaved aerated concrete units according to EN 771-4

³⁾ Deck elements made of light expanded clay aggregates. Density of the fastening layer is 1500 kg/m³

⁴⁾ OSB boards type 3 according to EN 300

⁵⁾ See clause 4.3 regarding drill hole diameter and depth

Washers		
Product	Mechanical resistance before and after heat ageing ETAG 006 §§5.3.4.3 and 5.3.7.2	Durability ETAG 006 §§ 5.3.7.1
ISO-TAK 45 and 75 (polypropylene)	Pass/Pass	Not relevant
ISO-TAK Twin Peak plus (polyamide)		
ISO-TAK RP 45 and 75 Plus (polypropylene)		
ISO TAK PP-45 -Mast (polyamide)		
ISO TAK Twin Peak standard (polypropylene)		
ISO-TAK 40 Metal stress plate	Not relevant	Pass
ISO-TAK SP-A-8240 D1 & D2		
ISO-TAK SPB-8240 D4 with studs		

Annex 4

Design principles for fastening Protan roofing membranes

Standard overlap system

Fig. 4.1 shows typical roof construction with mechanically fastened Protan roofing membrane. Fig. 4.2 shows standard overlap design. The fasteners should be installed with a distance of 30 mm to the edge of the membrane. Each side-lap is 120 mm wide on 1 m wide rolls, and 130 mm wide on 2 m wide rolls. Welding with automatic hot air welding machines gives up to 40 mm wide welding seams. Minimum 20 mm width of the hot air welding seams must be of an accepted quality. Each roll is premarked to help the installer to achieve good alignment.

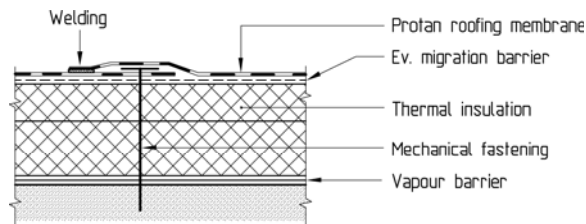

Fig. 4.1
Example of roof design with Protan SE and a separate migration barrier on a substrate of EPS insulation

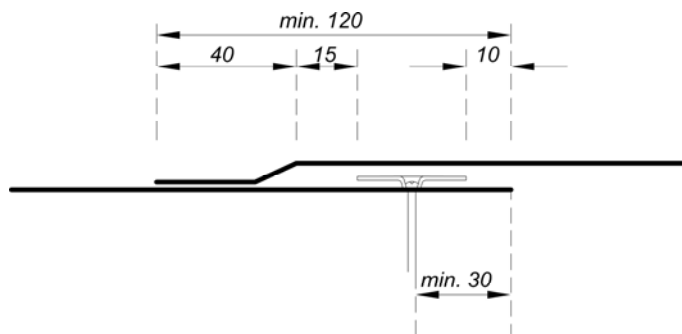

Fig. 4.2
Standard overlap

In addition to the calculated number of fasteners depending on the required wind up-lift resistance the maximum distance between fasteners also depends on the roll width. The following requirements must be met:

	Design wind pressure	
	$Q_d \leq 3,0 \text{ kN/m}^2$	$Q_d > 3,0 \text{ kN/m}^2$
Maximum distance between row of fasteners: corner and perimeter area field zone	1,0m No requirement	0,6m 1,0m
Maximum distance between fasteners in one row: corner and perimeter area field zone	1,0m 1,0m	0,6m 1,0m
Minimum distance between fasteners in one row:	0,2m	0,2m
Minimum number of fasteners:	1 fastener / m ²	2 fasteners / m ²

,The joints must resist both horizontal and vertical forces when the roofing is exposed to high wind loads. Hence, the welding seams must be smooth, and have a free space of about 15 mm between fastener and welding seam.

Hidden fixing system

The hidden fixing system, see Fig. 4.3, uses 2 m wide Protan SE membrane with min 120 mm wide extra strengthening strips, welded to the underside of the membrane in the factory at regular intervals. Normally the strips are placed transverse to the roll length with spacings varying from 400 mm to 1200mm. Adjacent rolls have minimum 40 – 100 mm wide overlaps and are hot air welded to the adjacent membrane sheet. A minimum 20 mm proper welding seam is required.

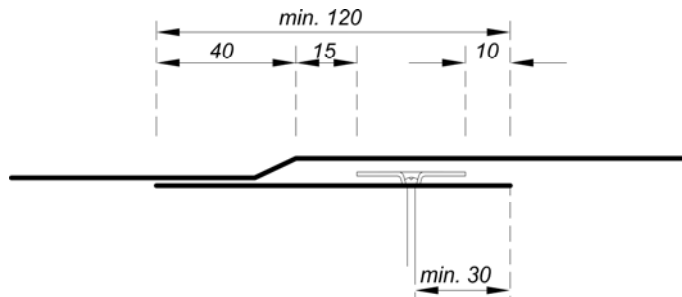

Fig. 4.3
Hidden fixing system

Field zone fixing with cover strip

Fig. 4.4 shows the principle for installation of fasteners in the field zone of the membrane sheet. The fastening points are covered with prefabricated welded patches or cover strips. This method allows location of fasteners in all places of the membrane sheet. Welded areas are subjected to tension forces only.

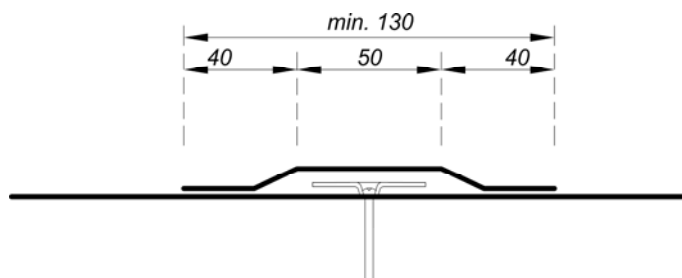

Fig. 4.4
Fastening in field of sheet

Fixing through overlap with coverstrip

Fig. 4.5 shows the principle for installation of fasteners through the membrane sheets with 50 mm overlaps. The fasteners are installed through the overlap with stress plates edges inside the edges of the membrane overlap. The fastening points are covered with cover strips, and with a minimum 20 mm wide proper welding seams on both sides of the stress plates. Welded areas are subjected to tension forces only.

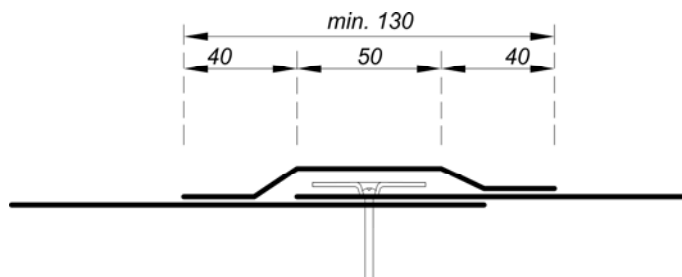

Fig. 4.5
Fastening through overlap with cover